



ALUMINIUM PROFILES

- ▶ ALUMINIUM PROFILES EXTRUSION
- ▶ MACHINING
- ▶ POWDER COATING
- ▶ ANODIZING

ALIPLAST EXTRUSION

Aliplast Extrusion, the Polish part of the international Corialis Group, is a producer of aluminium profiles working on the Polish and European market for more than 10 years. The product range of Aliplast Extrusion includes standard profiles and special sections for Customer's individual solutions. The company has four presses for extrusion of aluminium profiles with potential of almost 50 thousand tonnes per year.

- ▶ two Tecalex lines with a pressure of 2200 T and 2800 T
- ▶ two SMS lines with a pressure of 2400 T

The company offers advanced possibilities of mechanical treatment of aluminium profiles and surface, i.e. anodizing and powder coating.

Corialis Group Core Innovative Aluminium Integrated Solutions is an international group of companies: Aliplast NV & Aliplast Extrusion NV in Belgium, Profils Systèmes in France, Aliplast Sp. z o.o. & Aliplast Extrusion Sp. z o.o. in Poland, Smart Systems Ltd. & Smart Extrusion Ltd. in Great Britain, Centroalum S.A. in Spain, Aliplast Aluminium Systems d.o.o. in Serbia, Lingote-Aluminios in Portugal, H-Systems in South Africa Ltd., JMD Systems on the island of Réunion. Corialis is a leading player in the design and manufacturing of high quality, technologically-advanced aluminium profiles and systems.



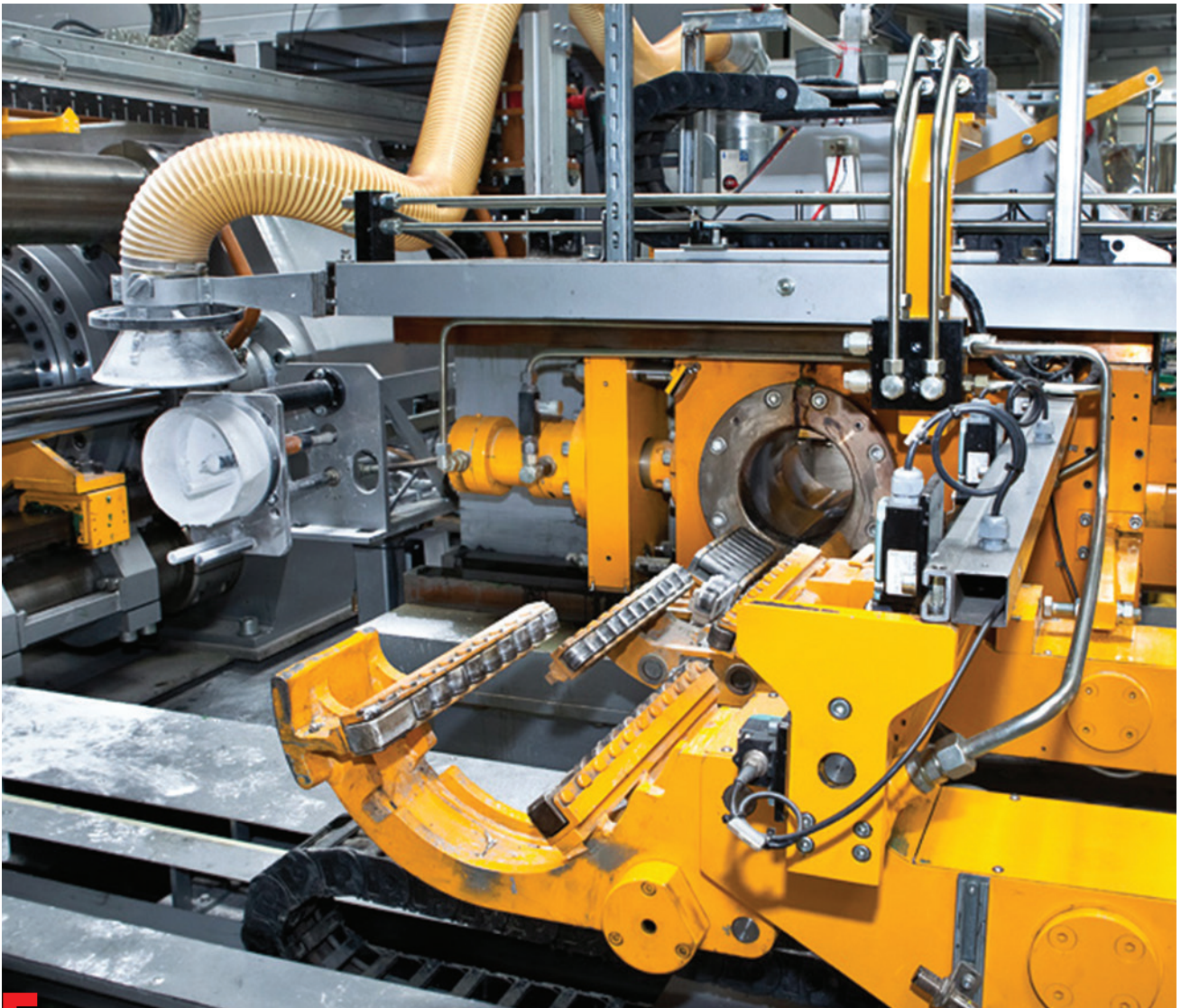

press 1/8"

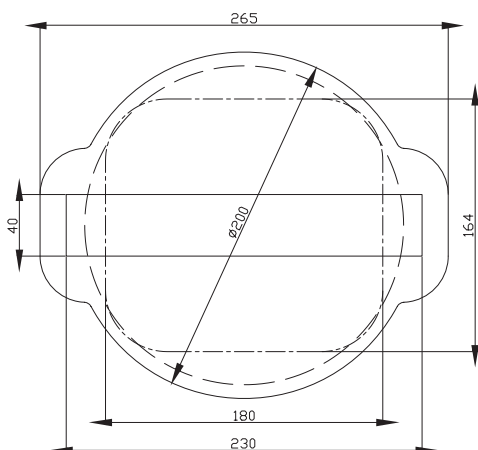

TECHNICAL CAPABILITIES

Alloys:

EN AW 1050, 6060, 6063, 6005A, 6101

pressure: 2200 T

min. weight of profile: 0,2 kg/m

max. width of profile: 230 mm

standard length of profile: 4000-7000 mm

length of profile: 7000 mm

MOQ min.: 500 kg/profile

order quantity tolerance: +/-20%

min. wall thickness: 1,2 mm

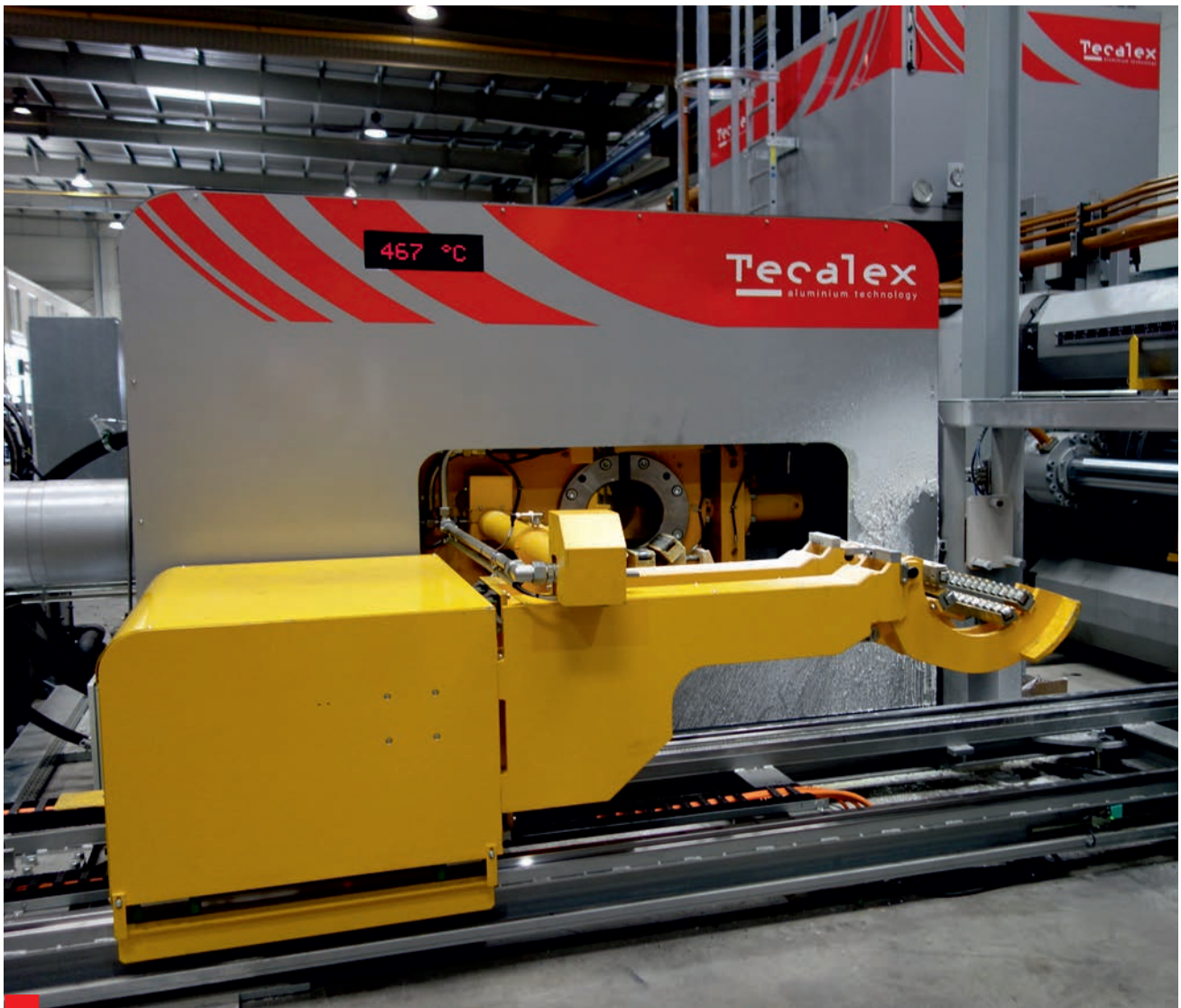

press 2/9"

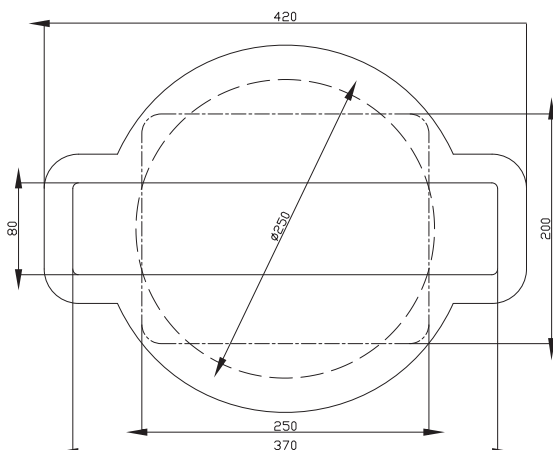

TECHNICAL CAPABILITIES

Alloys:

EN AW 1050, 6060, 6063, 6005A, 6082, 6101

pressure:	2800 T
min. weight of profile:	0,9 kg/m
max. width of profile:	370 mm
standard length of profile:	4000-7000 mm
length of profile:	14000 mm
MOQ min.:	1000 kg/profile
order quantity tolerance:	+/-10%
min. wall thickness:	1,2 mm



press 3/8"

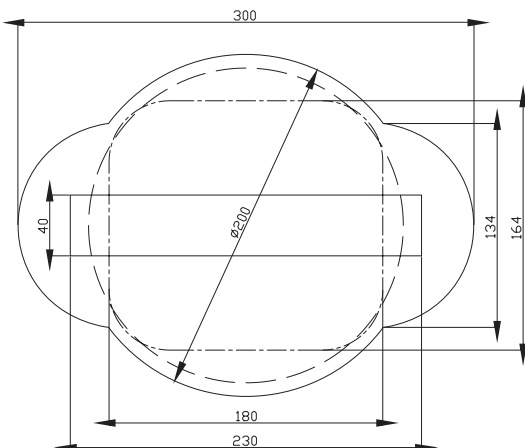

TECHNICAL CAPABILITIES

Alloys:

EN AW 1050, 6060, 6063, 6005A, 6101

pressure: 2400 T

min. weight of profile: 0,2 kg/m

max. width of profile: 230 mm

standard length of profile: 4000-7000 mm

length of profile: 14000 mm

MOQ min.: 500 kg/profile

order quantity tolerance: +/-20%

min. wall thickness: 1,2 mm



press 4/8"

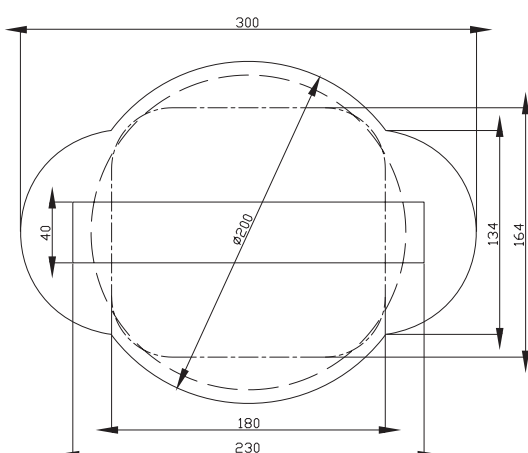

TECHNICAL CAPABILITIES

Alloys:

EN AW 1050, 6060, 6063, 6005A, 6101

pressure: 2400 T

min. weight of profile: 0,2 kg/m

max. width of profile: 230 mm

standard length of profile: 4000-7000 mm

length of profile: 14000 mm

MOQ min.: 500 kg/profile

order quantity tolerance: +/-20%

min. wall thickness: 1,2 mm

POWDER COATING



Aliplast Extrusion has the state-of-the-art powder coating line. The applied modern paint coating techniques and state-of-the-art machine fleet allow obtaining products that meet the quality standards and the highest requirements of the Customer. The own laboratory provides ongoing control of the aluminium surface preparation process before painting, and experienced personnel constantly supervise the correctness of manufacturing processes while maintaining the relevant European QUALICOAT standards (license number: 1518) and QUALIDECO (license number PL-0001).

1ST VERTICAL POWDER COATING LINE

- ▶ dimension of profiles 200 mm x 100 mm x 7400 mm
- ▶ fully automated line for powder coating aluminium profiles
- ▶ the capacity of 750 m² per hour
- ▶ modern and ecological technology

2ND VERTICAL POWDER COATING LINE

- ▶ dimension of profiles 200 mm x 100 mm x 7000 mm
- ▶ full automated
- ▶ production line output: 750 m² per hour
- ▶ two V-shaped cabins with 20 guns per cabin
- ▶ powder coating application using the latest GEMA product – AP 1.1 powder pumps with the dense phase powder coating flow technology
- ▶ a new generation powder coating polymerizing oven

The technology of the Aliplast Extrusion paint line ensures:

- ▶ reliability in maintaining the shape of workpieces
- ▶ elimination of the appearance of stripes with a lighter and darker colour
- ▶ modern and ecological technology, fully supplied by rainwater from the underground reservoir
- ▶ chrome-free treatment



POWDER COATING



HORIZONTAL POWDER COATING LINE

- ▶ fully automated powder coating line for aluminium profiles with a capacity of 360 m² per hour

HORIZONTAL POWDER COATING LINE DEDICATED TO FLAT WORKPIECES

- ▶ maximum dimensions: 4000 mm x 1500 mm x 500 mm
- ▶ state-of-the-art powder coating equipment Opti Star 4.0 with Gema Opticenter CM40 on two parallel powder coating booths
- ▶ automatic detection of the workpiece/start of painting/selection of the manipulator stroke height and the number of working powder guns (optical system)
- ▶ powder application in the Cleanroom technology - filtered atmosphere with controlled temperature, humidity and overpressure
- ▶ the average capacity of 70 m² per hour, the line equipped with double overhead conveyor systems
- ▶ speed 2.5 m/min on each of the 2 conveyors

POWDER COATING LINE DEDICATED TO ALUMINIUM ACCESSORY

- ▶ horizontal, manual varnishing line
- ▶ chemical treatment dedicated to aluminum castings
- ▶ an automatic manipulator that goes through the entire chemical treatment process
- ▶ state-of-the-art Gema OptiFlex 2Q application (new solution ensuring fast colors during the process of painting - 30 seconds)



ALIPLAST WOOD COLOUR EFFECT



The aluminium decoration line in the Decoral system allows obtaining decorations imitating the structure of wood (Aliplast Wood Colour Effect) and Aliplast Loft View stone surfaces.

- ▶ functionality – fully automated production process (productivity, 80-120 profiles per hour)
- ▶ automated film welding process (ultrasound head)
- ▶ pass-through furnace

The Decoral process technology makes it possible to paint both profile sections and aluminium sheets. **Aliplast Wood Colour Palette Effect** contains 18 wood colours: classic golden oak, golden oak, walnut, winchester, pine, mahogany, dark mahogany, wenge, golden cherry, siena rosso, siena PL, swamp oak, beech, bleached oak, bleached beech, turner oak, golden walnut and burned mahogany.

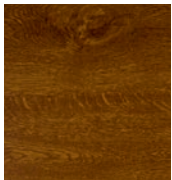

classic golden oak



golden oak

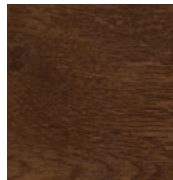

walnut

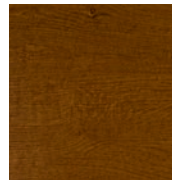

winchester



pine

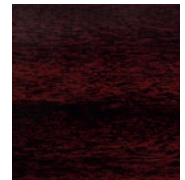

mahogany

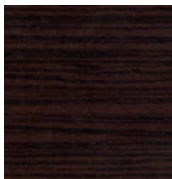

dark mahogany

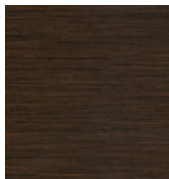

wenge

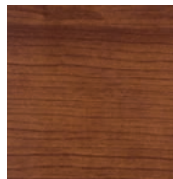

golden cherry

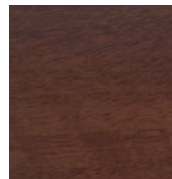

siena rosso

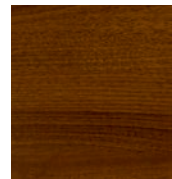

siena PL

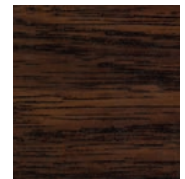

swamp oak



beech



bleached beech



bleached oak



turner oak

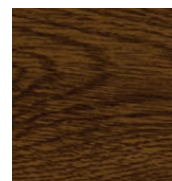

golden walnut

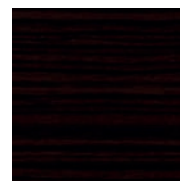

burned mahogany

The Aliplast Loft View palette includes 3 decoration options imitating stone surfaces:

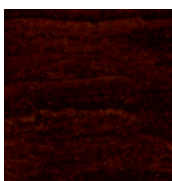

rustic rust



light concrete

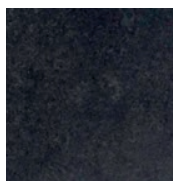

dark concrete



ANODIZING

Anodizing is an electrochemical process that converts the metal surface into a decorative, durable, corrosion-resistant, anodic oxide finish. Aluminium is ideally suited to anodizing, although other nonferrous metals, such as magnesium and titanium, also can be anodized. Aliplast Extrusion has a line for anodizing with a maximum length of up to 7200 mm, for refining of aluminium surfaces, used, among others, in construction, interior decoration, automotive industry, shipbuilding, construction carpentry and furniture production. The quality of anodized is confirmed by the QUALANOD - certificate No.1808.

SHOT-BLASTING

Abrasive blasting performed in order to homogenise the surface and obtain uniform structure of the material. A dedicated service for materials with high aesthetic requirements. The minimum length of the material to be processed is 4000 mm.

BRUSHING

Type of treatment used to obtain a decorative surface of aluminium profiles. It effectively masks lines and wide strips and provides the possibility to remove minor mechanical damage. The minimum length of the workpiece is 4000 mm. Flat and parallel surfaces can be brushed.

Aliplast Extrusion offers following colours: **C-0** natural, **C-31** light champagne, **C-32** champagne, **C-33** olive, **C-34** bronze and **C-35** black

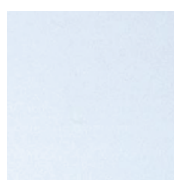

C-0

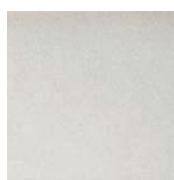

C-31

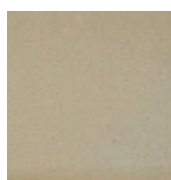

C-32

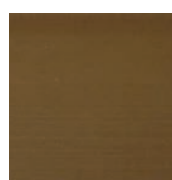

C-33

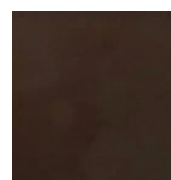

C-34

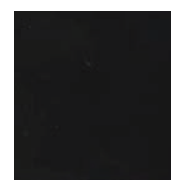

C-35



[MACHINING

Aliplast Extrusion is a company providing comprehensive solutions from the manufacturing of aluminium profiles to mechanical processing and surface treatment services. The company invests in a high technological level – modern machining centres accelerate and streamline production processes while maintaining high quality services.

ALIPLAST EXTRUSION PROCESS FLEET:

- ▶ 3 CNC machines
- ▶ 5 milling plotters
- ▶ 4 saws for cutting profiles
- ▶ cutting press for sheets
- ▶ sheet metal bending machine
- ▶ 3 bending machines for profiles
- ▶ 2 stations for tumble finishing
- ▶ 1 welding station

Aliplast Extrusion offers mechanical working of profiles using three- and four-axis numerically controlled machining centres. The scope of machining using the numerical centre includes: profile milling, sheet metal milling, threading, engraving, drilling, cutting the ends of profiles.

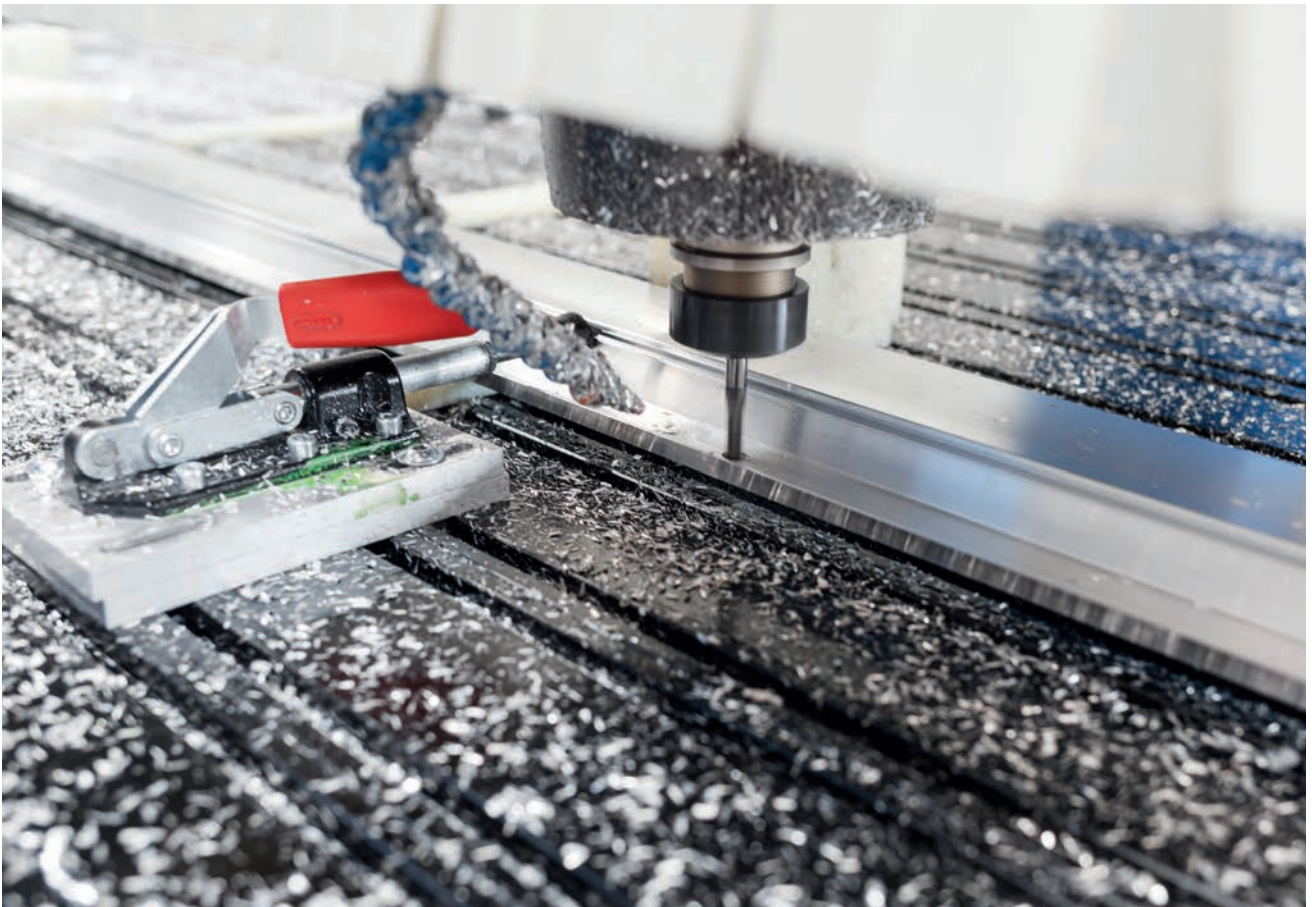

CORIALIS EXTRUSION PRESSES



	Aiplast Aluminium Extrusion		Aiplast Extrusion			
	P1	P2	P1	P2	P3	P4
Press	2200 T - 8"	4400 T - 12"	2200 T - 8"	2800 T - 9"	2400 T - 8"	2400 T - 8"
Alloys	EN AW 6060, 6061, 6063, 6005, 6005A	EN AW 6060, 6061, 6063, 6005, 6005A, 6082	EN AW 1050, 6060, 6063, 6005A, 6101	EN AW 1050, 6060, 6063, 6005A, 6082, 6101	EN AW 1050, 6060, 6063, 6005A, 6101	EN AW 1050, 6060, 6063, 6005A, 6101
Weight of profile	0.3 - 3 kg/m	1 - 18 kg/m	0.2 - 8 kg/m	0.9 - 18 kg/m	0.2 - 8 kg/m	0.2 - 8 kg/m
Max length of profile	8000 mm	14000 mm	7000 mm	14000 mm	14000 mm	14000 mm
Max width of profile	230 x 50 mm	385 x 50 mm	230 x 50 mm	370 x 50 mm	230 x 50 mm	230 x 50 mm
Max square	140 x 140 mm	180 x 180 mm	140 x 140 mm	190 x 190 mm	140 x 140 mm	140 x 140 mm
Max diameter	200 mm	254 mm	230 mm	250 mm	200 mm	200 mm
Capacity per year	10 000 tons	15 000 tons	10 000 tons	12 000 tons	12 000 tons	12 000 tons





Smart Aluminium Extrusion				Profils Systèmes		Lingote Aluminios		
P1	P2	P3	P4	P1	P2	P2	P3	P4
2200 T - 8"	2500 T - 8"	1400 T - 6"	2500 T - 8"	2200 T - 8"	2500T-8"	2200 T - 8"	2800 T - 9"	2500 T - 8"
EN AW 6060, 6063, 6063A	EN AW 6060, 6063, 6063A, 6005A, 6082	EN AW 6060, 6063, 6063A	EN AW 6060, 6063	EN AW 1050, 6060, 6063, 6005, 6005A, 6082	EN AW 1050, 6060, 6063, 6005, 6005A, 6082	EN AW 6060, 6063, 6005A	EN AW 1050, 6060, 6063, 6005A	EN AW 6060, 6063, 6005A
0.25 - 8 kg/m	0.25 - 8 kg/m	0.15 kg - 2 kg/m	0.25 kg - 5 kg/m	0.3 - 3 kg/m	0.3 - 3 kg/m	0.3-8 kg/m	1 - 18 kg/m	1-8 kg/m
14600 mm	14600 mm	7500 mm	7500 mm	8600 mm	8600 mm	7000 mm	7000 mm	14000 mm
230 x 50 mm	230 x 50 mm	100 x 50 mm port/ 140 x 10 mm flat	200 x 50 mm	230 x 50 mm	230 x 50 mm	250 x 70 mm	310 x 81 mm	250 x 70 mm
140 x 140 mm	140 x 140 mm	90 x 90 mm	140 x 140 mm	140 x 140 mm	140 x 140 mm	145 x 145 mm	190 x 190 mm	140 x 140 mm
200 mm	200 mm	100 mm	150 mm	200 mm	200 mm	205 mm	266 mm	205 mm
10 000 tons	10 000 tons	5 000 tons	10 000 tons	10 500 tons	10 500 tons	9 000 tons	10 000 tons	9 500 tons



QUALITY

Aliplast Extrusion strives for continuous improvement and complete elimination of defects from the moment of feeding the production material to the finished product leaving the company.

Quality control in Aliplast Extrusion includes: data analysis, strength tests, hardness measurements, measurements of profile dimensions. On-site tests of mechanical properties are carried out and the obtained results can be used to issue the 3.1 acceptance certificate. With the implemented and continuously maintained Factory Production Control, Aliplast Extrusion can issue declarations of performance for the manufactured profiles.



ENVIRONMENT

Aliplast Extrusion is a modern and dynamically developing company specialising in the production of aluminium profiles. The basis of the Company's business model is sustainable development, both in the product offer and in manufacturing processes.

Aliplast Extrusion means an innovative and environmentally friendly solutions optimising production processes, advanced management systems, safe working environment, reasonable environmental policy, sustainable use of resources, environmentally friendly waste management and pollution prevention.

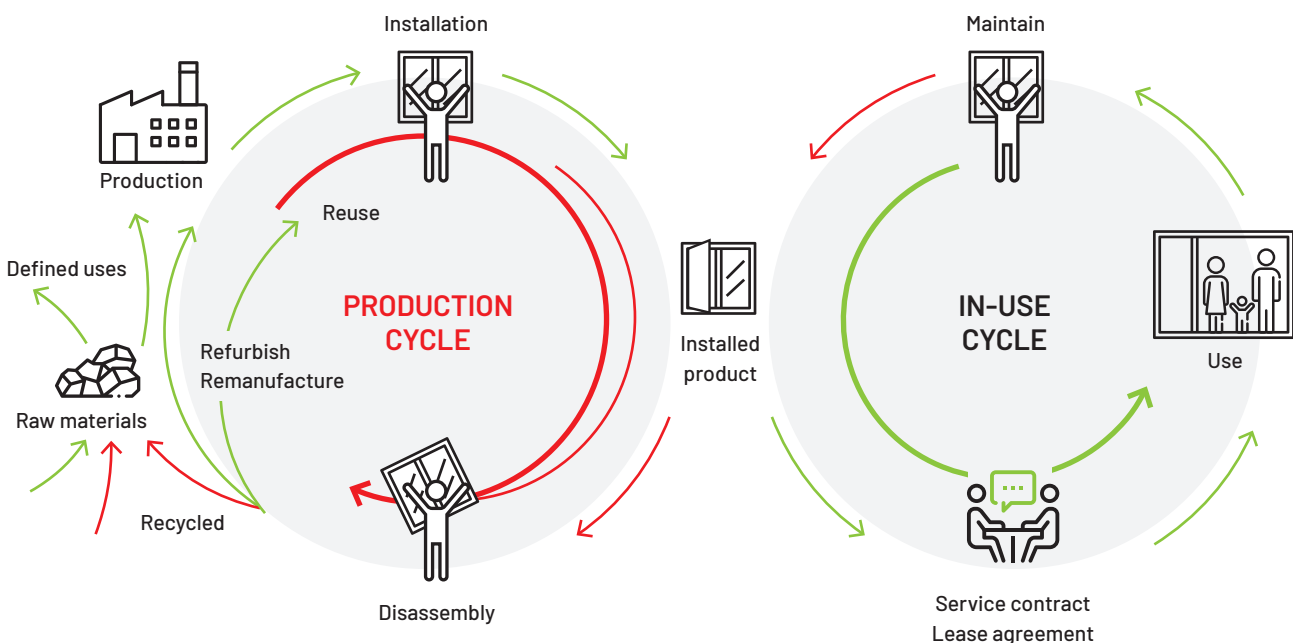

CORIALIS GROUP



Europe

- 1 Aliplast NV - Belgium
Aliplast Aluminium Extrusion NV - Belgium
- 2 Aliplast Sp. z o.o. - Poland
Aliplast Extrusion Sp. z o.o. - Poland
- 3 Smart Systems Ltd. - Great Britan
Smart Extrusion Ltd. - Great Britan
- 4 Profils Systèmes - France
- 5 Lingote Aluminios S.A. - Portugal
- 6 Aliplast Aluminium Systems d.o.o. - Serbia
- 7 Centroalum S.A. - Spain
- 8 Gutmann - Germany

Africa and Oceania

- 9 JMD Systems - Réunion
- 10 H Systems Ltd - South Africa





aliplast
aluminium extrusion

Aliplast Extrusion Sp. z o.o.
ul. Wacława Moritza 3
20-276 Lublin, Poland

Contact

t: +48 81 710 68 00
e: extrusion@aliplast.pl

www.aliplastextrusion.pl

